



above-desk | below-desk | beyond-desk

cmd.

Power module

NEX3001 instructions

Safety warning

For your safety, this product must be installed in accordance with local Building Regulations.

If in any doubt, or where required by the law, consult a competent person who is registered with an electrical self-certification scheme. Wiring should be in accordance with the latest edition of the IET regulations (BS 7671) . If the unit is being installed in an office environment by means of a 13A plug please ensure BS6396 is adhered to.

Please read carefully and use in accordance with these safety wiring instructions. Before commencing any electrical work ensure the supply is switched off at the mains. To prevent fire hazard always use cable of the correct rating & type for the application.

Warning do not exceed the load rating of this device as stated on the rear of the product.

Built in protection

This product has been designed to protect connected equipment as well as end user.

Each socket outlet has protection in the form of a 3A resettable thermal fuse that detects overloads or any defective equipment that may be connected.

continued 

click for [nexus.uk](https://www.nexus.uk)

Connecting in to the NEX3001

The NEX3001 has input and output GST18 connections. Please ensure that the input cable has a female GST18 connector complete with locking clip. Push the input connector into the NEX3001 until the clip engages and you hear a “click” (additional Weiland clip also supplied to suit standard CMD starter lead).

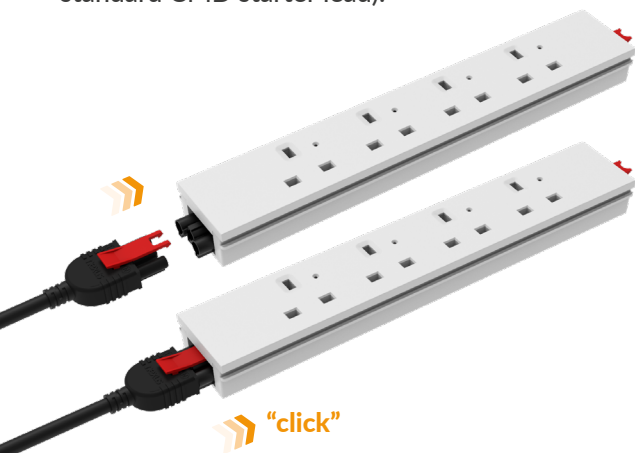

Resetting the built in protective device

If there is no power due to an overloaded socket or defective equipment being connected, the built in protection switch will operate. A red indicator will be raised and the protection switch will need resetting.

Please follow the below steps to reset the device:

- 1 Remove plug.

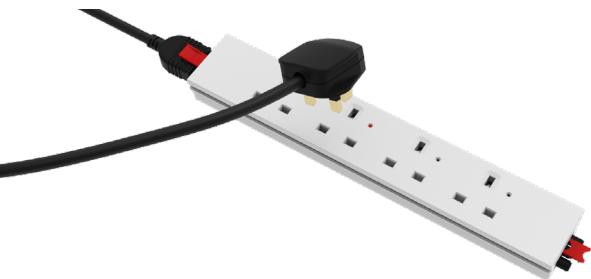

continued v

click for nexus.uk

2

Confirm the red indicator beneath the plug has risen.

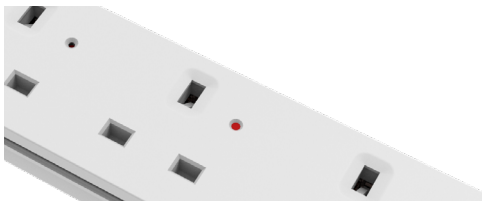

3

Locate a tool and insert it into the reset opening.

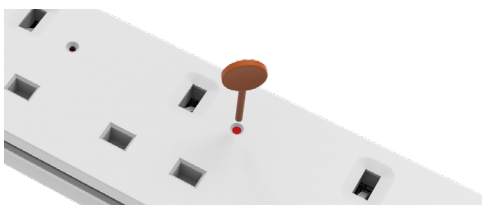

4

Push until it clicks.

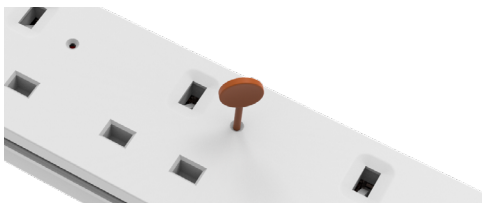

5

Remove tool.



6

Once the fault has been investigated and rectified reconnect the equipment.

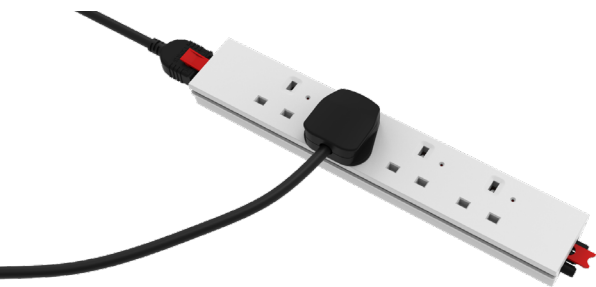

Technical

Voltage: 220-240V ac

Frequency: 50/60Hz

Rating:

4x 3A individual resets

Maximum load:

2880 Watts

Through connection max
load 16A

Standards: Tested to
BS5733, BS1363-2

Construction:

Polycarbonate, VO rated
ABS/PC blend current
carrying plastic

Connectors: 4 sockets.
3 pole GST18 input and
output

Mounting options:

Standalone, or use nexus
3021 below-desk extrusion
& accessories

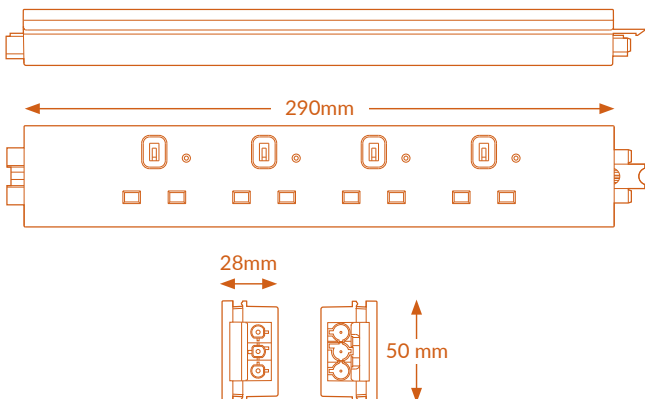

continued v

click for [nexus.uk](https://www.nexus.uk)

ASTA Approved

The ASTA quality mark is evidence that the product has been independently tested to comply with the relevant clauses of the applicable standards.



Service conditions

This module is only suitable for use under the following conditions of service:

- 1 An ambient temperature range of -5°C to $+40^{\circ}\text{C}$, with an average value not exceeding $+35^{\circ}\text{C}$ over one full day.
- 2 An altitude not exceeding 2000m above sea level.
- 3 An atmosphere not subject to excessive pollution by smoke, chemical or flammable fumes; salt-laden spray; prolonged periods of high humidity or other abnormal conditions.
- 4 Not suitable for exposure to direct radiation from the sun or other source of heat likely to raise the temperature above the designated ambient, nor may it be suitable for subjection to excessive vibration.

Where service conditions differ from those prescribed above the advice of the manufacturer or responsible vendor should be sought.

Batch code explanation

yyWxx Manufacturing date code, year of manufacture (yy) and week of manufacture (Wxx)

Address / Helpline

Workstation power and ergonomics quotations and
Technical Support:

sales@cmd-ltd.com

To speak to a member of our team, please call the
number below and select the option required:

+44 (0) 1709 829 511

Environmental protection



This symbol is known as the
“Crossed-out Wheellie Bin”.

This product should not be disposed
of with general household waste.

Some chemicals contained within
electrical/electronic products can be
harmful to health and environment.
Only dispose of electrical/electronic
items in separate collection schemes,
which cater for the recovery and
recycling of materials contained
within. Your co-operation is vital to
ensure the success of these schemes
and for the protection of the
environment.

BS6396:2008 Electrical Systems in Office and Educational Furniture

BS6396 applies to electrical installations in office and educational furniture connected to the supply by a 13A plug. Most commonly this is via an outlet within a floor box or a perimeter trunking system. Installations connected by other means such as underfloor track tap-offs, industrial connectors or hard wiring should be installed in accordance with BS7671 - Requirements for Electrical installations.

To meet the requirements of BS6396 the points listed below must be followed when installing an electrical system within office or educational furniture.

Any electrical system being fed from one 13 Amp UK plug must not consist of more than;

- Six sockets if individually fused at 3.15 Amps each
- Four sockets if individually fused at 5 Amps each



www.cmd-ltd.com

HEAD OFFICE

Eastwood Trading Estate
Rotherham, South Yorkshire
S65 1EN

+44 (0)1709 829 511
sales@cmd-ltd.com

LONDON SHOWROOM

3 Baltic Street East
London
EC1Y 0UJ

+44 (0)20 7251 7080
sales@cmd-ltd.com

SALES INTO EU

(EU) Luceco SE, C/ Bobinadora 1-5,
08302 Mataró, SPAIN